

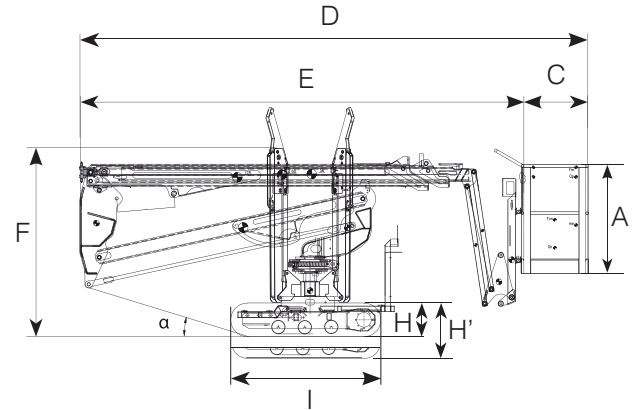

PERFORMANCE	
WORKING HEIGHT	17.60 m
HORIZONTAL OUTREACH (120 KG.)	8.50 m
UP AND OVER CLEARANCE	5.30 m
CAGE CAPACITY	200 Kg
MOVABLE JIB	90°
CAGE ROTATION	180°
TURRET ROTATION	320°
GRADEABILITY	30%
SLOPE ANGLE (α)	12° - 17°
TRAVEL SPEED	2.0 Km/h

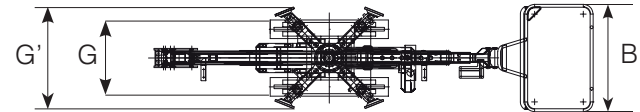

MEASURES	
CAGE HEIGHT (A)	1.10 m
CAGE LENGTH (B)	1.10 m
CAGE WIDTH (C)	0.70 m
LENGTH (D)	5.57 m
LENGTH WITHOUT CAGE (E)	4.78 m
HEIGHT (TRAVELLING POSITION) (F)	1.95 m
WIDTH, MIN (G)	0.89 m
WIDTH, MAX (G')	1.10 m
GROUND CLEARANCE, MIN (H)	0.18 m
GROUND CLEARANCE, MAX (H')	0.22 m
TRACK (L x W) (I)	1.60x 0.20 m
LENGTH OUTRIGGER STANDARD (J)	3.10 m
WIDTH OUTRIGGER STANDARD (K)	3.10 m
OUTRIGGER PLATE (\varnothing)	0.20 m



WEIGHT	
TOTAL WEIGHT	2330 Kg
TRAVEL CONFIGURATION PRESSURE	2.30 kN/m ²
WORK CONFIGURATION PRESSURE	2.45 kN/m ²
MAX OUTRIGGER FORCE	14.03 kN

POWER SOURCES	
STANDARD Petrol Engine	9.6 kW
STANDARD Electric Motor	230V - 2.2 kW
OPTIONAL Diesel Engine	7.3 kW
OPTIONAL Lithium Battery	48V - 100 Ah
FUEL TANK CAPACITY Diesel Engine	5 l
OIL TANK CAPACITY	30 l

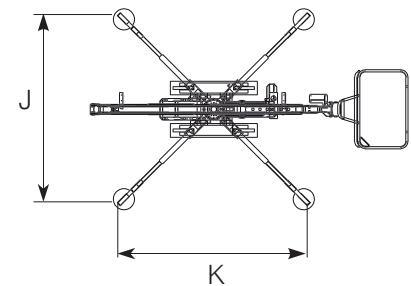

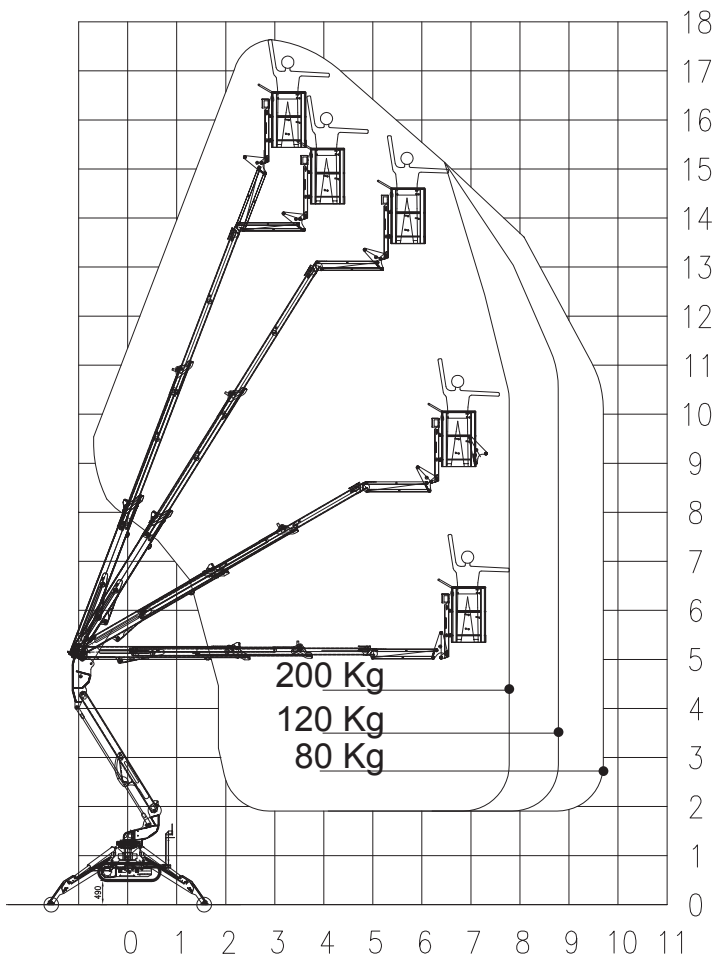

CHASSIS

- Powerful track drive with hydraulic braking system
- Precise manoeuvring
- Rubber tracks with specially arranged profile providing optimum grip

BOOM SYSTEM

- Single pantograph with telescopic boom
- Articulated Jib 90°
- Turnable basket 180°
- Fully hydraulic controls
- Hydraulic cage self levelling system
- Turret rotation with slewing ring

OPTIONS

- Battery drive (lithium) 48V 100 Ah (R180BA)
- Outrigger self levelling system
- Outrigger pads
- Non marking rubber tracks
- Custom paintwork
- Cable control
- Radio control (tracks + outriggers)
- Electric pump for emergency lowering

POWER SOURCES

- 110V (US) / 230V (EU) electric motor
- 9.6 kW Honda petrol engine
- Start/ Stop device for the engine in the cage

PRODUCTIVITY, SAFETY & QUALITY

- 110V (US) / 230V (EU) power socket in the cage
- High quality paint in RAL 9003 & RAL 2001
- Hand pump for emergency lowering
- Lock valves on hydraulic cylinders
- Relief valves protecting the hydraulic system from too high pressures
- Protective covers for all components
- Hour meter