

## Lifting capacity diagram, OK2

Catalogue no.	Section
31 133	22
Date	Page
09-04-2018	1 (1)

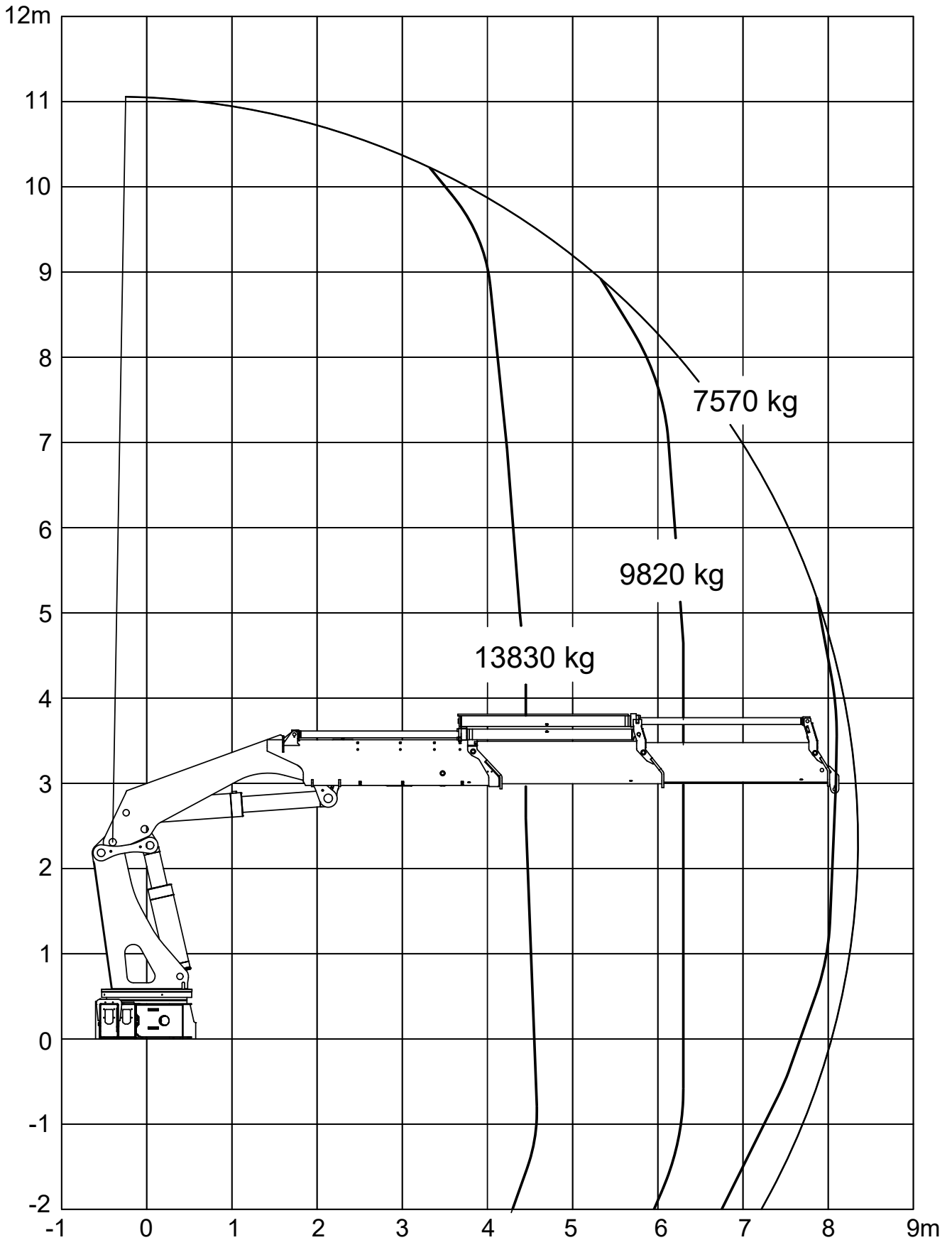

## Lifting capacity diagram, OK3

Catalogue no.	Section
31 133	23
Date	Page
09-04-2018	1 (1)

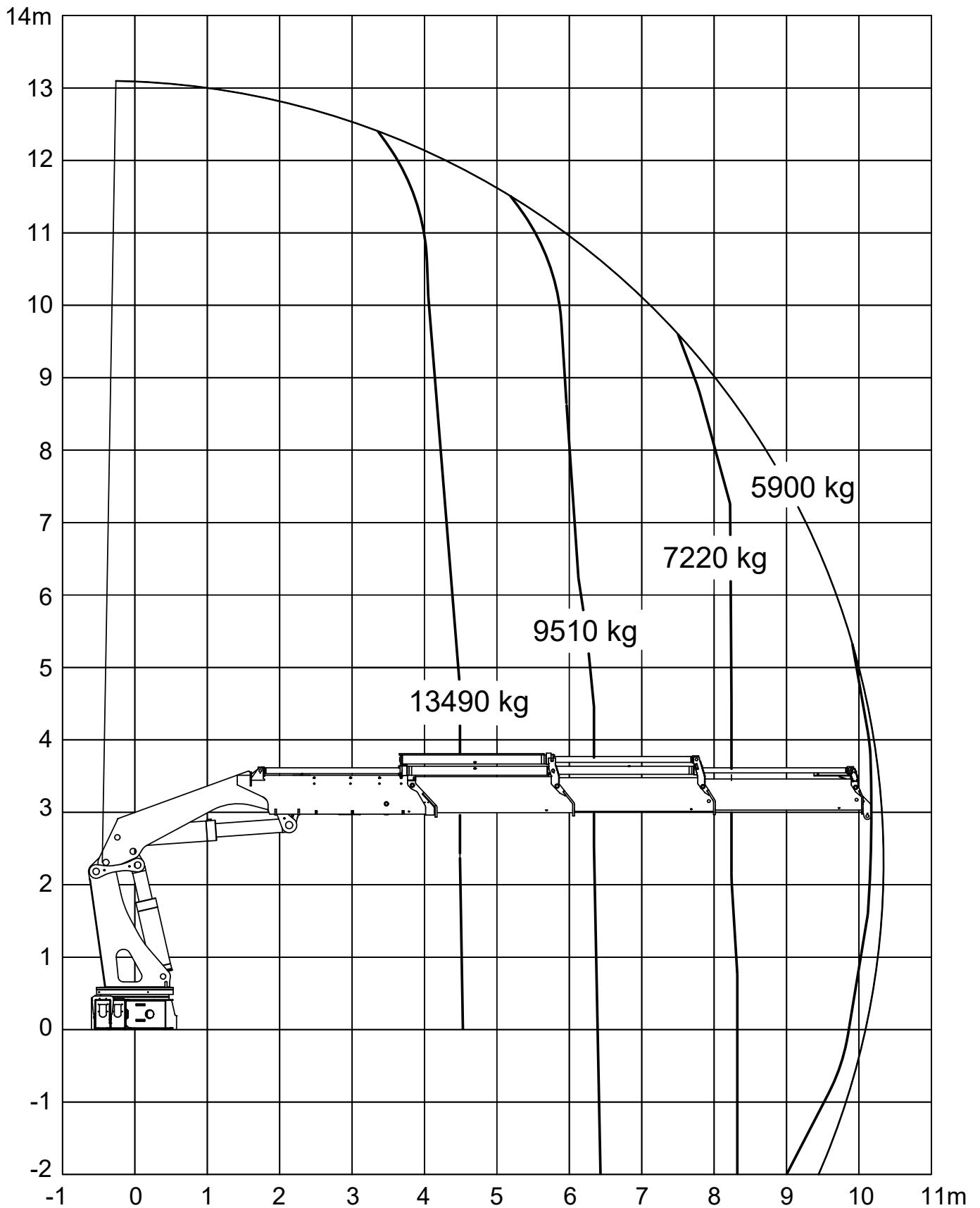

## Lifting capacity diagram, OK4

Catalogue no.	Section
31 133	24
Date	Page
09-04-2018	1 (1)

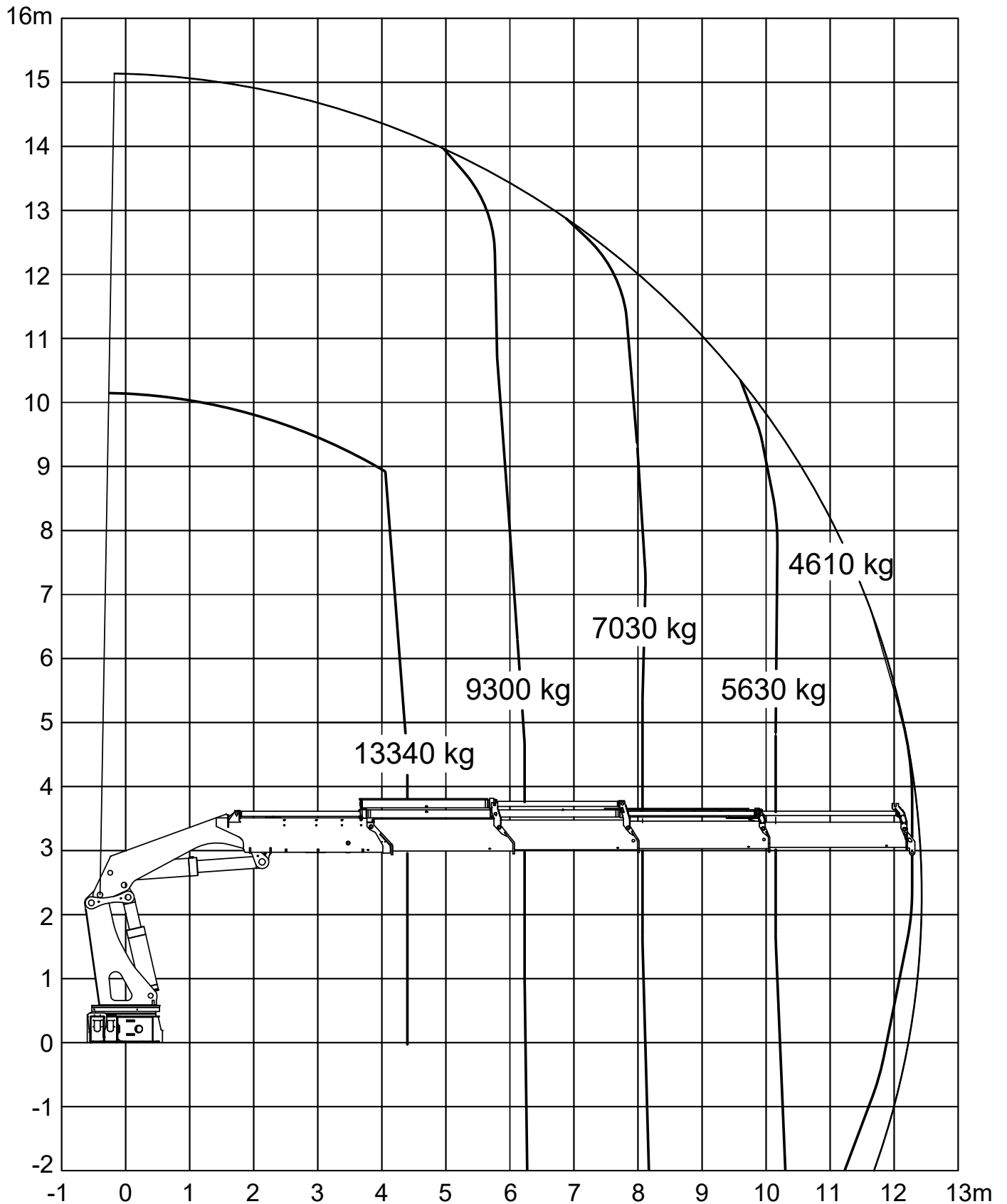

## Lifting capacity diagram, OK5

Catalogue no.	Section
31 133	25
Date	Page
09-04-2018	1 (1)

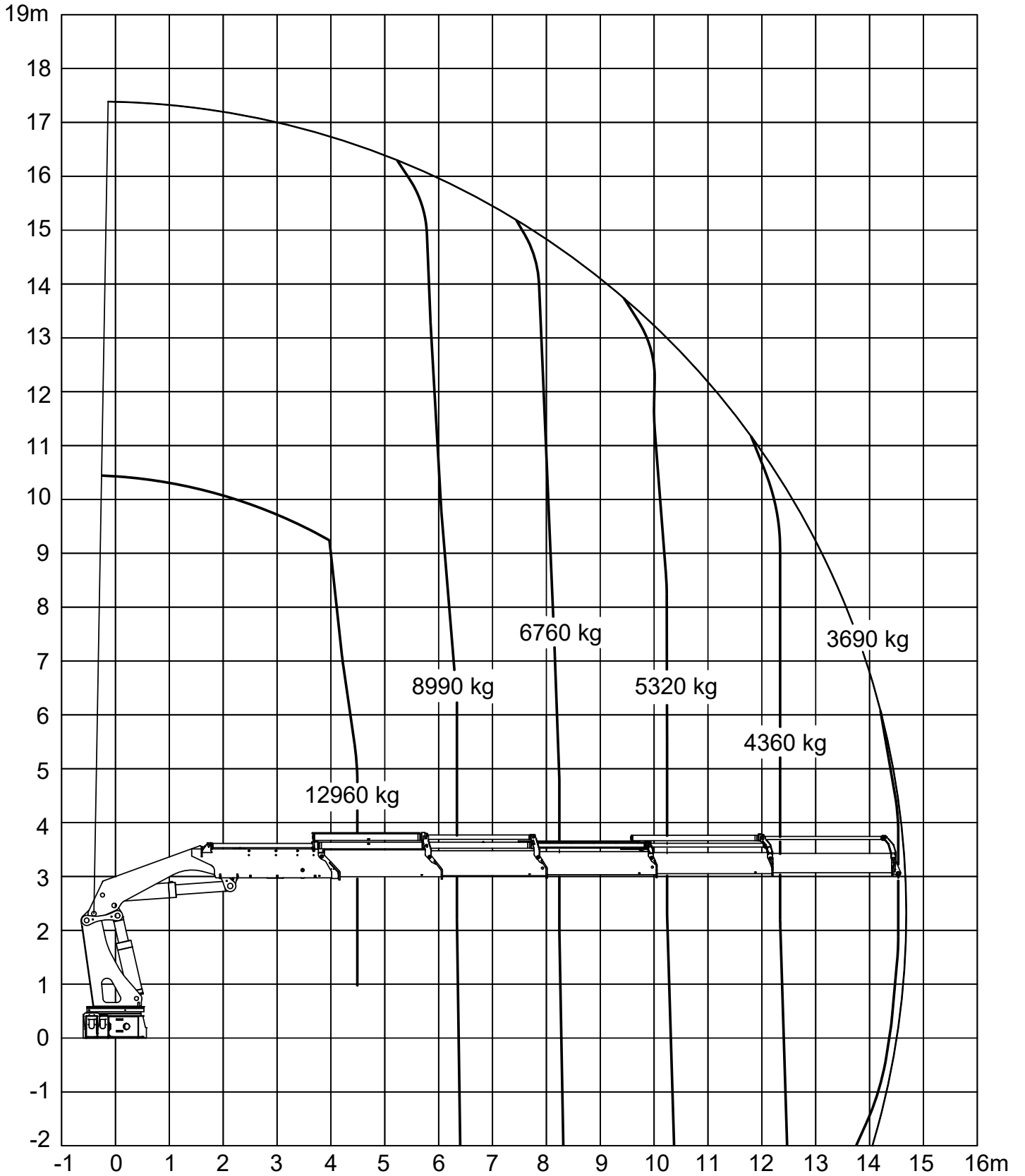

## Lifting capacity diagram, OK6

Catalogue no.	Section
31 133	26
Date	Page
09-04-2018	1 (1)

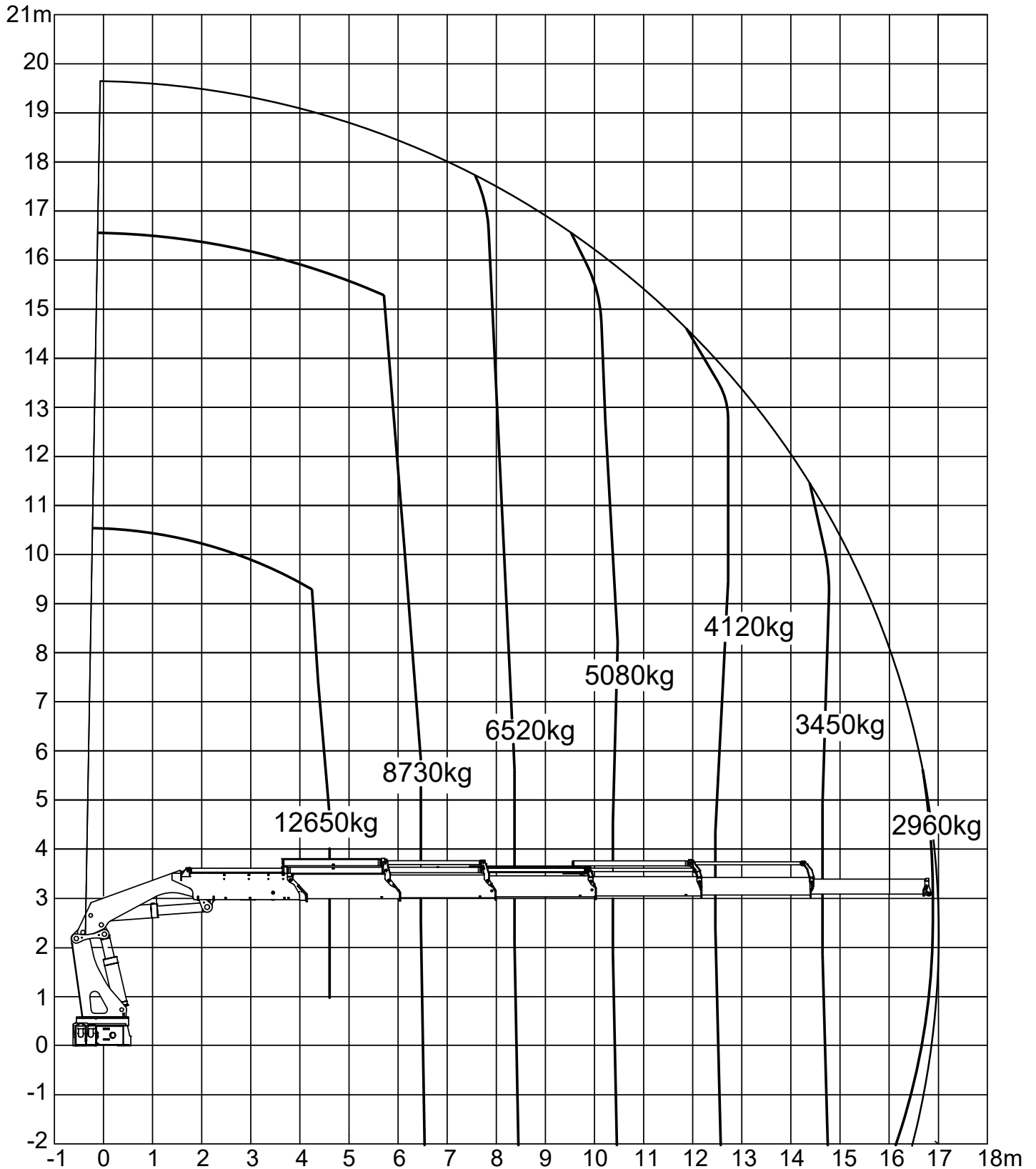

## Lifting capacity diagram, 7020-OK6 with FJ1200-K3

Catalogue no.	Section
31 133	240
Date	Page
23-06-2020	1 (1)

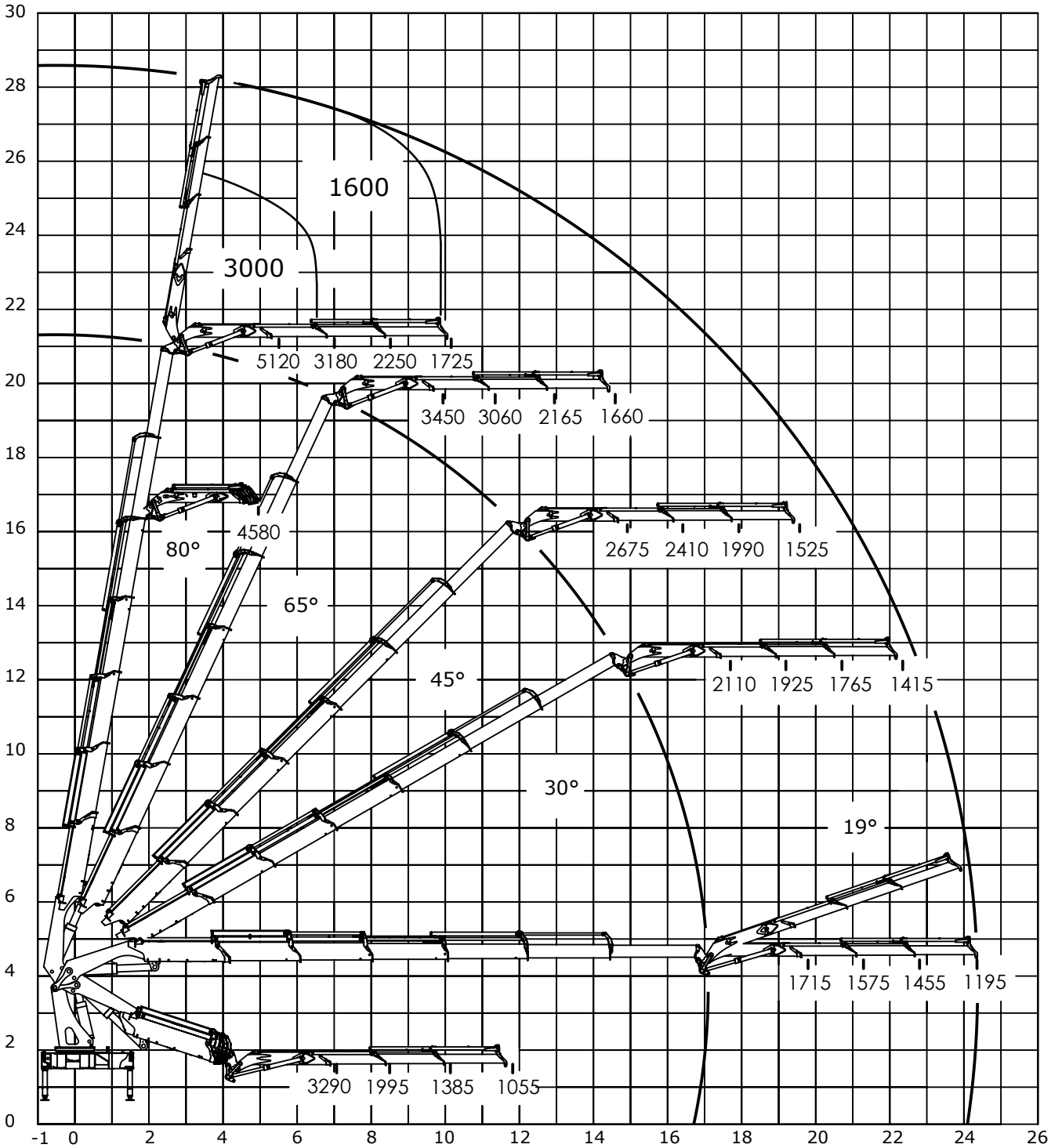

## Lifting capacity diagram, 7020-OK6 with FJ1200-K4

Catalogue no.	Section
31 133	241
Date	Page
23-06-2020	1 (1)

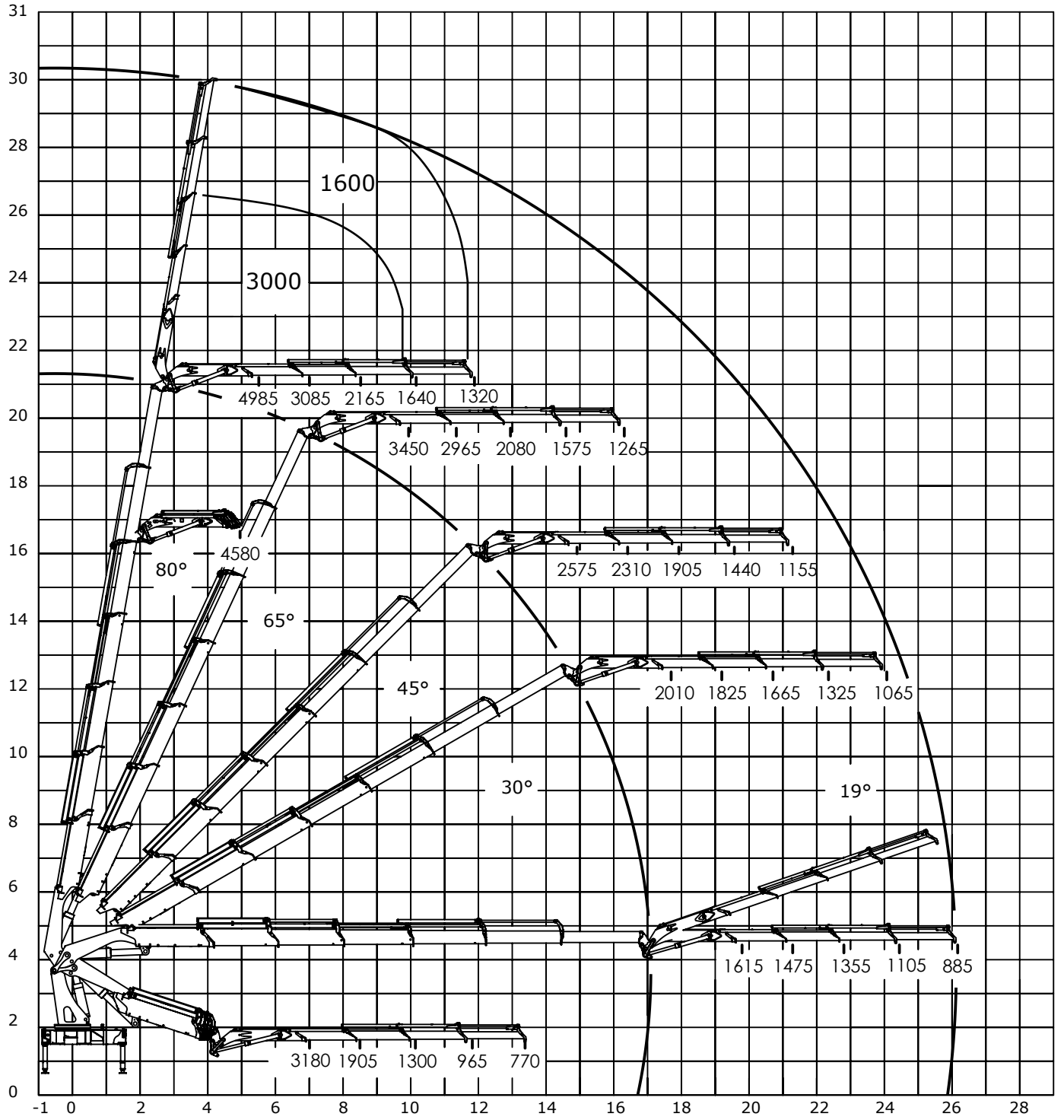

## Lifting capacity diagram, 7020-OK6 with FJ1200-K5

Catalogue no.	Section
31 133	242
Date	Page
23-06-2020	1 (1)

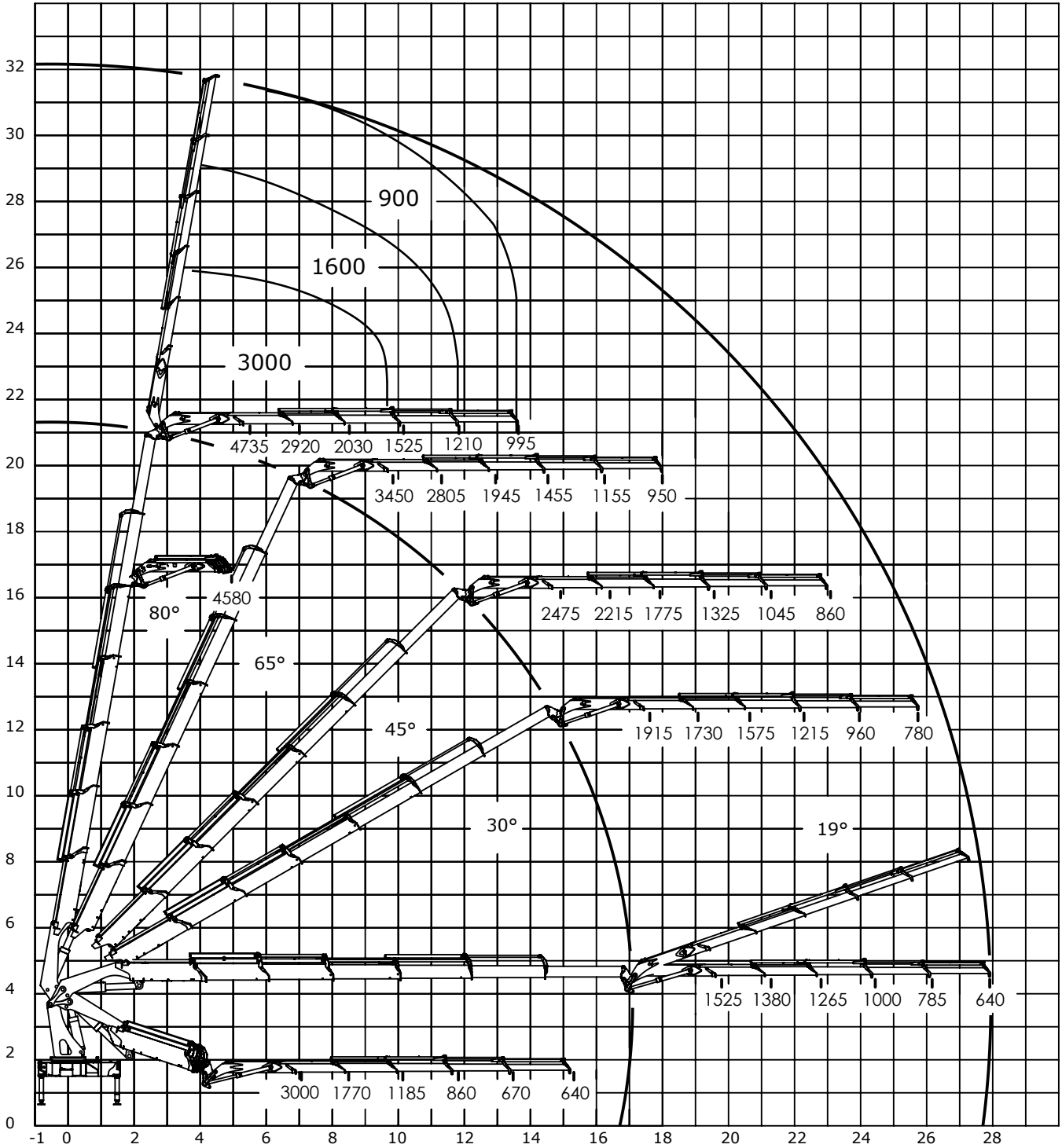



## Lifting capacity diagram, 7020-OK6 with FJ1200-K6

Catalogue no.	Section
31 133	243
Date	Page
23-06-2020	1 (1)

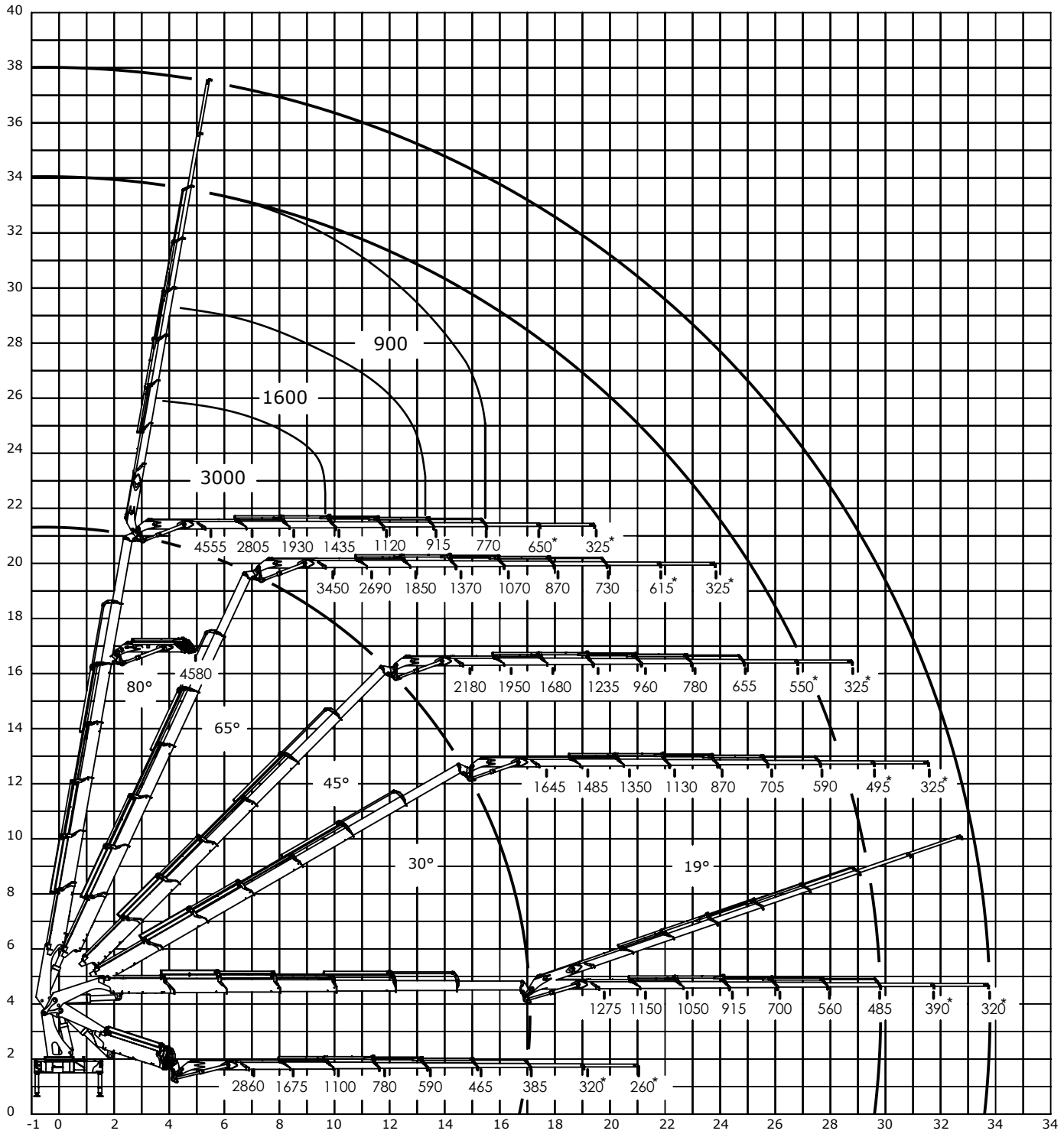

\* With manual extension.

